

DESCRIPTION

The HN3415B uses advanced trench technology to provide excellent $R_{DS(ON)}$, low gate charge and operation with gate voltages as low as 2.5V. This device is suitable for use as a load switch or in PWM applications.

GENERAL FEATURES

-

V_{DSS}	$R_{DS(ON)}$ @-4.5V(Typ)	$R_{DS(ON)}$ @-2.5V(Typ)	I_D
-18V	49m Ω	72m Ω	-4.2A

- High Power and current handing capability
- Lead free product is acquired
- Surface Mount Package

Application

- PWM applications
- Load switch
- Power management

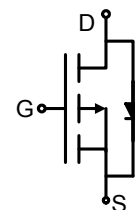

Schematic diagram

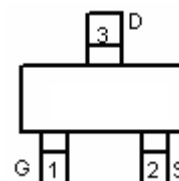

Marking and pin Assignment



SOT-23

Absolute Maximum Ratings (TA=25°C unless otherwise noted)

Parameter	Symbol	Limit	Unit
Drain-Source Voltage	V_{DS}	-18	V
Gate-Source Voltage	V_{GS}	± 12	V
Drain Current-Continuous	I_D	-4.2	A
Drain Current -Pulsed (Note 1)	I_{DM}	-10	A
Maximum Power Dissipation	P_D	1	W
Operating Junction and Storage Temperature Range	T_J, T_{STG}	-55 To 150	$^{\circ}C$

Thermal Characteristic

Thermal Resistance, Junction-to-Ambient (Note 2)	$R_{\theta JA}$	125	$^{\circ}C/W$
--	-----------------	-----	---------------

Electrical Characteristics (TA=25°C unless otherwise noted)

Parameter	Symbol	Condition	Min	Typ	Max	Unit
Off Characteristics						
Drain-Source Breakdown Voltage	BV_{DSS}	$V_{GS}=0V, I_D=-250\mu A$	-16	-18	-	V
Zero Gate Voltage Drain Current	I_{DSS}	$V_{DS}=-16V, V_{GS}=0V$	-	-	-1	μA

Gate-Body Leakage Current	I_{GSS}	$V_{GS}=\pm 12V, V_{DS}=0V$	-	-	± 100	nA
On Characteristics (Note 3)						
Gate Threshold Voltage	$V_{GS(th)}$	$V_{DS}=V_{GS}, I_D=-250\mu A$	-0.4	-0.7	-1	V
Drain-Source On-State Resistance	$R_{DS(ON)}$	$V_{GS}=-4.5V, I_D=-3A$	-	49	52	m Ω
		$V_{GS}=-2.5V, I_D=-2A$	-	72	80	m Ω
Forward Transconductance	g_{FS}	$V_{DS}=-5V, I_D=-2.8A$	-	9.5	-	S
Dynamic Characteristics (Note4)						
Input Capacitance	C_{iss}	$V_{DS}=-10V, V_{GS}=0V,$ $F=1.0MHz$	-	650	-	PF
Output Capacitance	C_{oss}		-	220	-	PF
Reverse Transfer Capacitance	C_{rss}		-	55	-	PF
Switching Characteristics (Note 4)						
Turn-on Delay Time	$t_{d(on)}$	$V_{DD}=-10V, I_D=-1A$ $V_{GS}=-4.5V, R_{GEN}=10\Omega$	-	11	-	nS
Turn-on Rise Time	t_r		-	35	-	nS
Turn-Off Delay Time	$t_{d(off)}$		-	30	-	nS
Turn-Off Fall Time	t_f		-	10	-	nS
Total Gate Charge	Q_g	$V_{DS}=-10V, I_D=-3A,$ $V_{GS}=-2.5V$	-	3.3	12	nC
Gate-Source Charge	Q_{gs}		-	0.7	-	nC
Gate-Drain Charge	Q_{gd}		-	1.3	-	nC
Drain-Source Diode Characteristics						
Diode Forward Voltage (Note 3)	V_{SD}	$V_{GS}=0V, I_S=1.3A$	-	-	-1.2	V
Diode Forward Current (Note 2)	I_S		-	-	-1.3	A

Notes:

1. Repetitive Rating: Pulse width limited by maximum junction temperature.
2. Surface Mounted on FR4 Board, $t \leq 10$ sec.
3. Pulse Test: Pulse Width $\leq 300\mu s$, Duty Cycle $\leq 2\%$.
4. Guaranteed by design, not subject to production

TYPICAL ELECTRICAL AND THERMAL CHARACTERISTICS

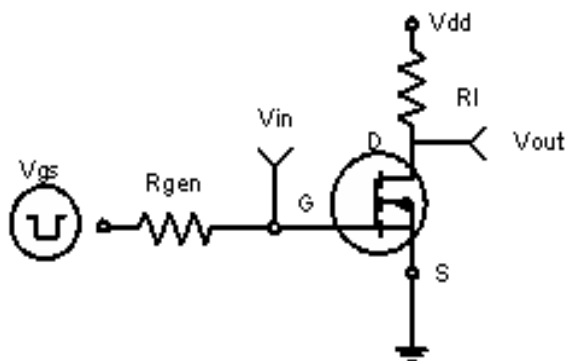

Figure 1: Switching Test Circuit

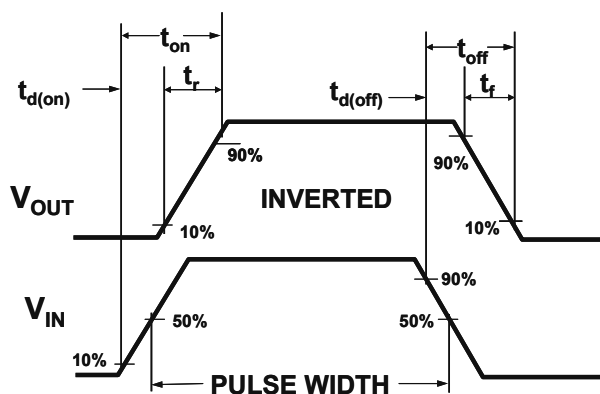

Figure 2: Switching Waveforms

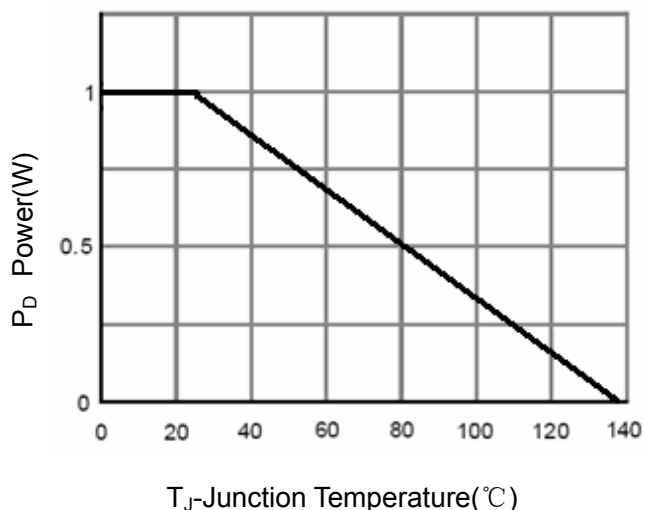

Figure 3 Power Dissipation

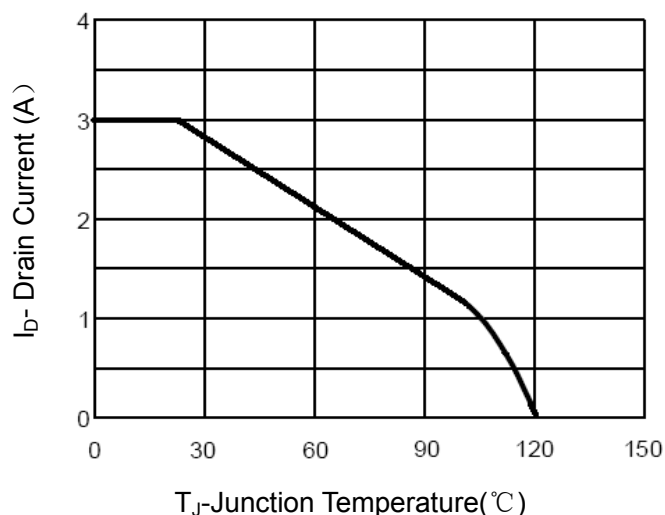

Figure 4 Drain Current

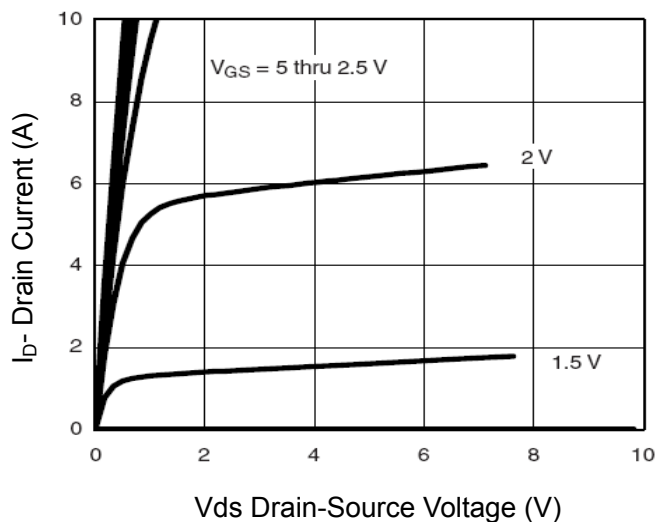

Figure 5 Output CHARACTERISTICS

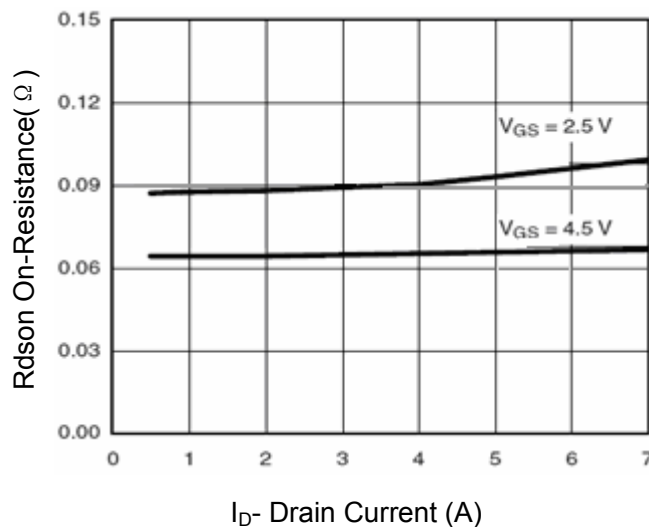
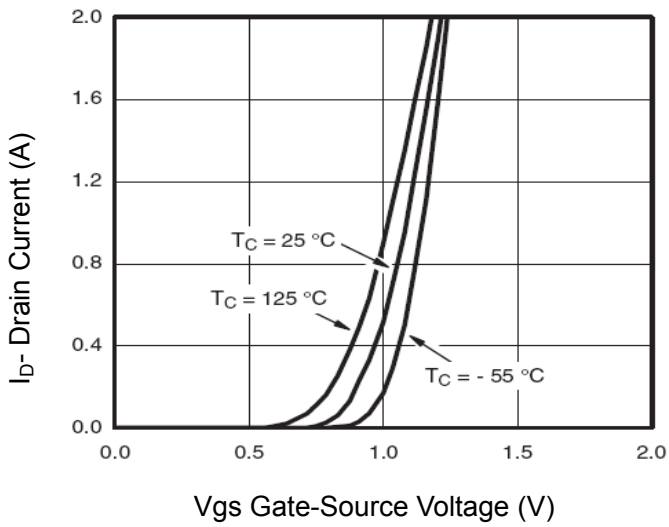
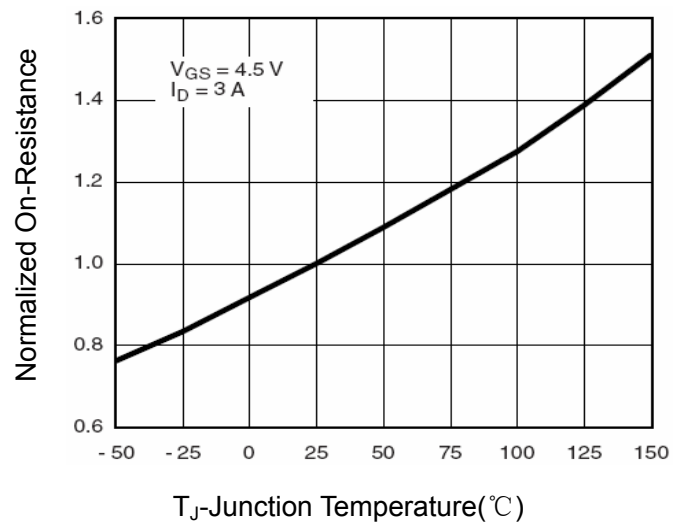

Figure 6 Drain-Source On-Resistance



Vgs Gate-Source Voltage (V)
Figure 7 Transfer Characteristics



T_J-Junction Temperature(°C)
Figure 8 Drain-Source On-Resistance

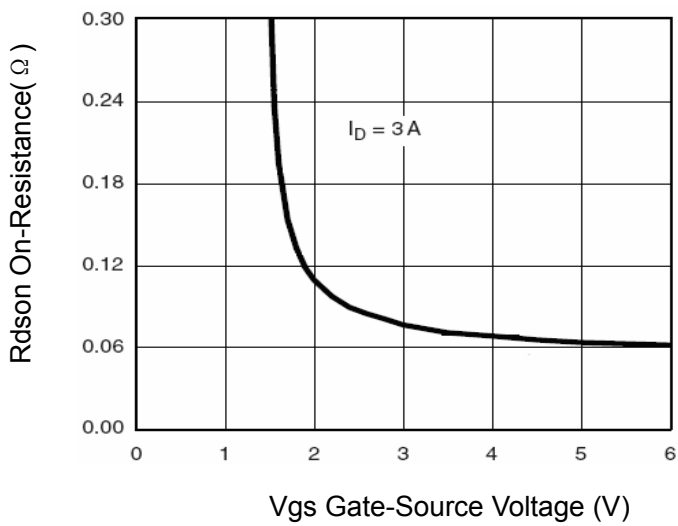

Vgs Gate-Source Voltage (V)
Figure 9 Rdson vs Vgs

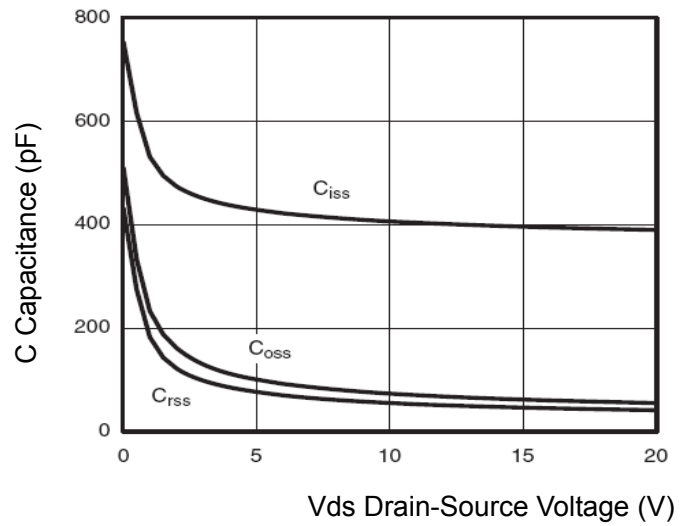

Vds Drain-Source Voltage (V)
Figure 10 Capacitance vs Vds

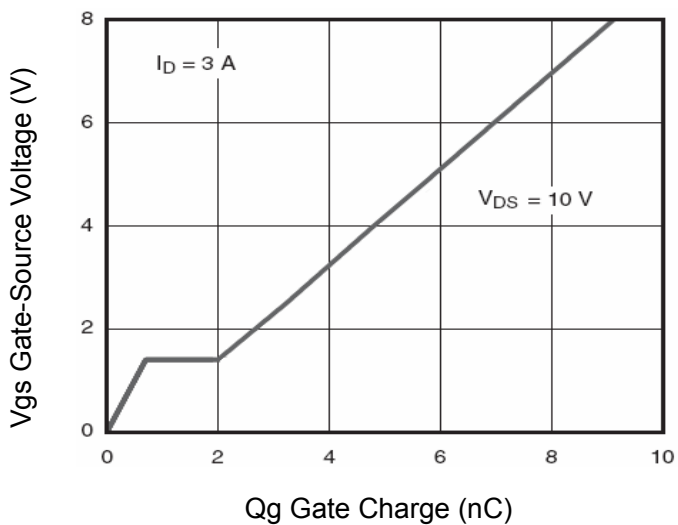

Qg Gate Charge (nC)
Figure 11 Gate Charge

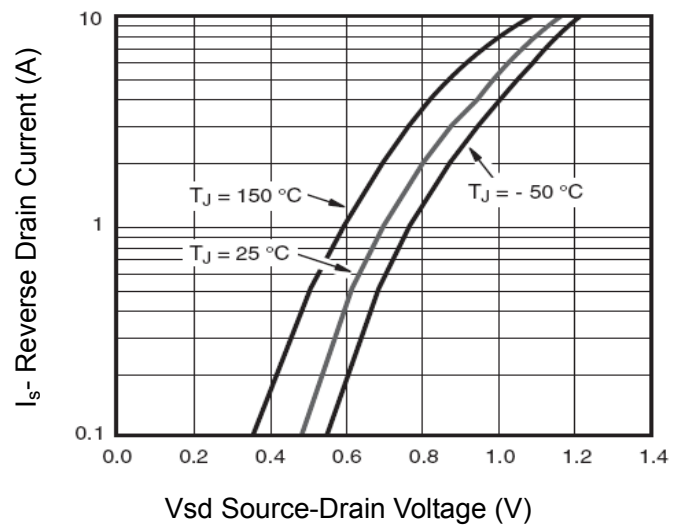

Vsd Source-Drain Voltage (V)
Figure 12 Source- Drain Diode Forward

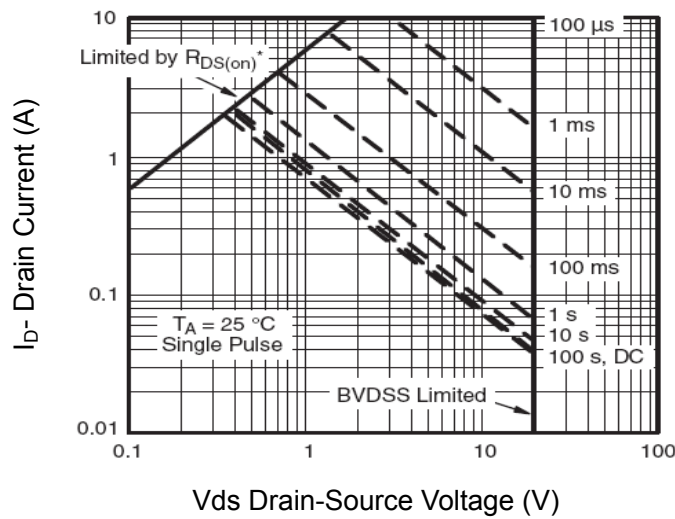

Figure 13 Safe Operation Area

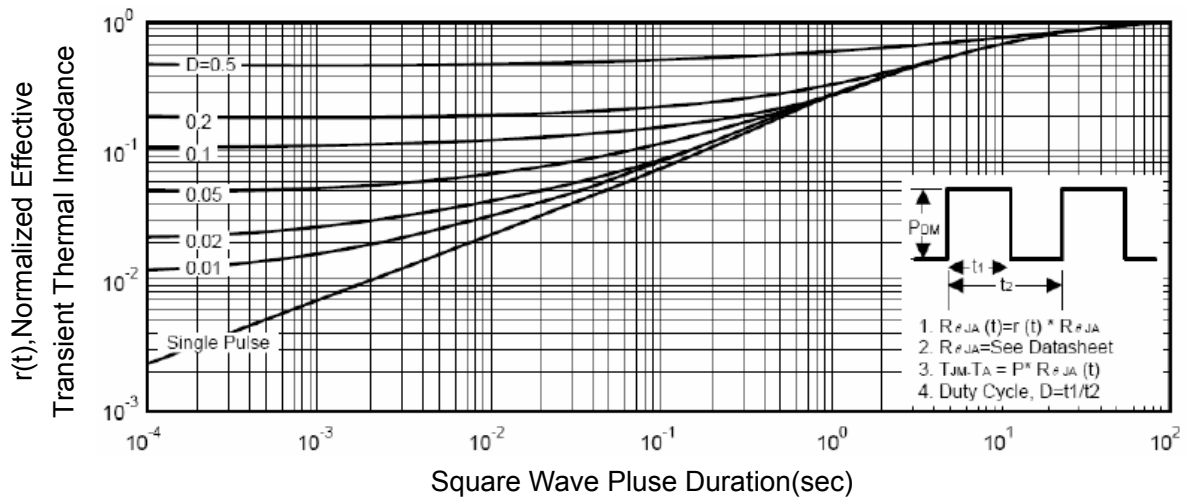

Figure 14 Normalized Maximum Transient Thermal Impedance