

## Trench Field-Stop Technology IGBT

### Features

- 650V, 50A
- $V_{CE(sat)(typ.)} = 1.8V @ V_{GE} = 15V, I_C = 50A$
- Maximum Junction Temperature 175°C
- Pb-free Lead Plating; RoHS Compliant

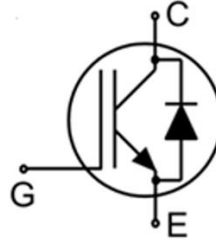

### Applications

- Solar Converters
- Uninterrupted Power Supply
- Welding Converters
- Mid to High Range Switching Frequency Converters

### Key Performance and Package Parameters

Order codes	$V_{CE}$	$I_C$	$V_{CEsat}, T_{vj}=25^{\circ}C$	$T_{vjmax}$	Marking	Package
XD050Q065AY1S3	650V	50A	1.8V	175°C	D50Q65AY1	TO247-3L

### Absolute Maximum Ratings

Symbol	Parameter	Value	Unit
$V_{CES}$	Collector-Emitter Voltage	650	V
$V_{GES}$	Gate-Emitter Voltage	±20	V
$I_C$	Continuous Collector Current ( $T_C=25^{\circ}C$ )	100	A
	Continuous Collector Current ( $T_C=100^{\circ}C$ )	50	A
$I_{CM}$	Pulsed Collector Current (Note 1)	200	A
$P_D$	Maximum Power Dissipation ( $T_C=25^{\circ}C$ )	214.3	W
	Maximum Power Dissipation ( $T_C=100^{\circ}C$ )	107	W
$T_J$	Operating Junction Temperature Range	-40 to 175	°C
$T_{STG}$	Storage Temperature Range	-55 to 150	°C

### Thermal Data

Symbol	Parameter	Conditions	Max.	Unit
$R_{\theta JC}$	Thermal Resistance, Junction to Case for IGBT	TO247-3L	0.7	°C/W

**Electrical Characteristics** ( $T_c=25^\circ\text{C}$  unless otherwise noted.)

Symbol	Parameter	Conditions	Min.	Typ.	Max.	Unit
$BV_{CES}$	Collector-Emitter Breakdown Voltage	$V_{GE}=0V, I_C=200\mu A$	650	---	---	V
$I_{CES}$	Collector-Emitter Leakage Current	$V_{CE}=650V, V_{GE}=0V$	---	---	40	$\mu A$
$I_{GES}$	Gate Leakage Current, Forward	$V_{GE}=20V, V_{CE}=0V$	---	---	100	nA
	Gate Leakage Current, Reverse	$V_{GE}=-20V, V_{CE}=0V$	---	---	100	nA
$V_{GE(th)}$	Gate Threshold Voltage	$V_{GE}=V_{CE}, I_C=500\mu A$	3.7	4.5	5.3	V
$V_{CE(sat)}$	Collector-Emitter Saturation Voltage	$V_{GE}=15V, I_C=50A, T_j=25^\circ\text{C}$	---	1.8	2.2	V
$Q_G$	Total Gate Charge	$V_{CC}=520V$	---	78	---	nC
$Q_{GE}$	Gate-Emitter Charge	$V_{GE}=15V$	---	12.5	---	nC
$Q_{GC}$	Gate-Collector Charge	$I_C=50A$	---	45	---	nC
$t_{d(on)}$	Turn-on Delay Time	$V_{CC}=400V$ $V_{GE}=\pm 15V$ $I_C=50A$ $R_G=20\Omega$ Inductive Load $T_C=25^\circ\text{C}$	---	15.3	---	ns
$t_r$	Turn-on Rise Time		---	50.7	---	ns
$t_{d(off)}$	Turn-off Delay Time		---	153	---	ns
$t_f$	Turn-off Fall Time		---	73.6	---	ns
$E_{on}$	Turn-on Switching Loss		---	0.47	---	mJ
$E_{off}$	Turn-off Switching Loss		---	0.72	---	mJ
$E_{ts}$	Total Switching Loss		---	1.19	---	mJ
$C_{ies}$	Input Capacitance	$V_{CE}=25V$	---	1230	---	pF
$C_{oes}$	Output Capacitance	$V_{GE}=0V$	---	132	---	pF
$C_{res}$	Reverse Transfer Capacitance	$f=1\text{MHz}$	---	39	---	pF

**Diode Characteristics** (  $T_C=25^{\circ}C$  unless otherwise noted)

Symbol	Parameter	Conditions	Min.	Typ.	Max.	Unit
$V_F$	Diode Forward Voltage	$I_F=50A, T_j=25^{\circ}C$	---	1.65	2.2	V
$t_{rr}$	Diode Reverse Recovery Time	$V_R=400V$	---	146.2	---	ns
$I_{rr}$	Diode peak Reverse Recovery Current	$I_F=50A$ $dI_F/dt=350A/us$	---	7.9	---	A
$Q_{rr}$	Diode Reverse Recovery Charge	$T_C=25^{\circ}C$	---	392	---	nC

Note1: Repetitive rating, pulse width limited by maximum junction temperature

## Typical Characteristics

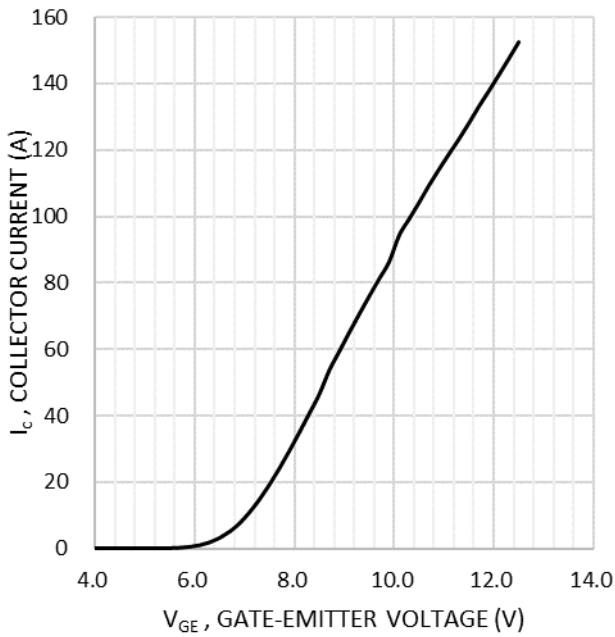

**Fig. 1 Typical transfer characteristics**  
( $V_{CE}=20V$ )

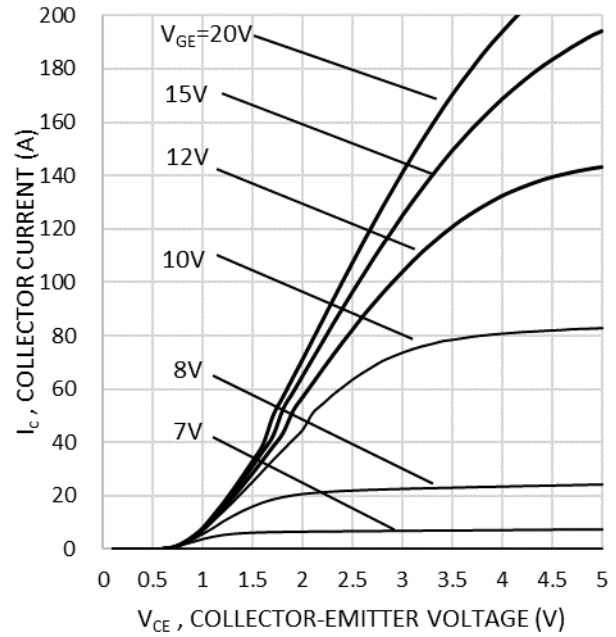

**Fig. 2 Typical output characteristic** ( $T_{vj}=25^{\circ}C$ )

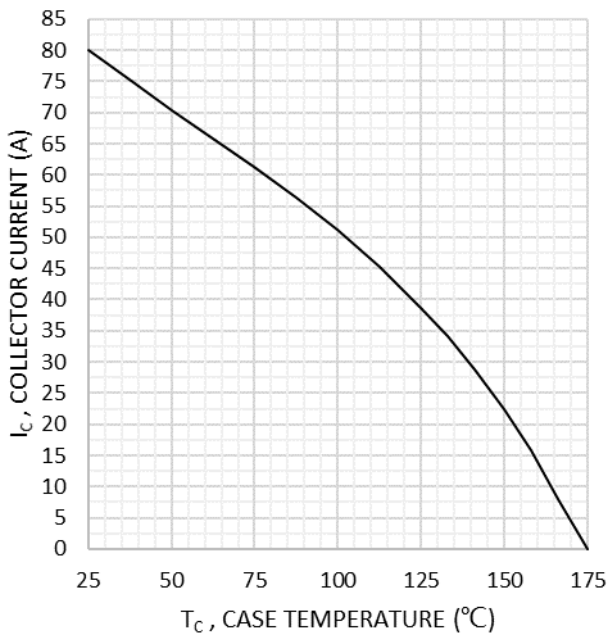

**Fig. 3 Collector current as a function of case temperature** ( $V_{GE} \geq 15V, T_{vj} \leq 175^{\circ}C$ )

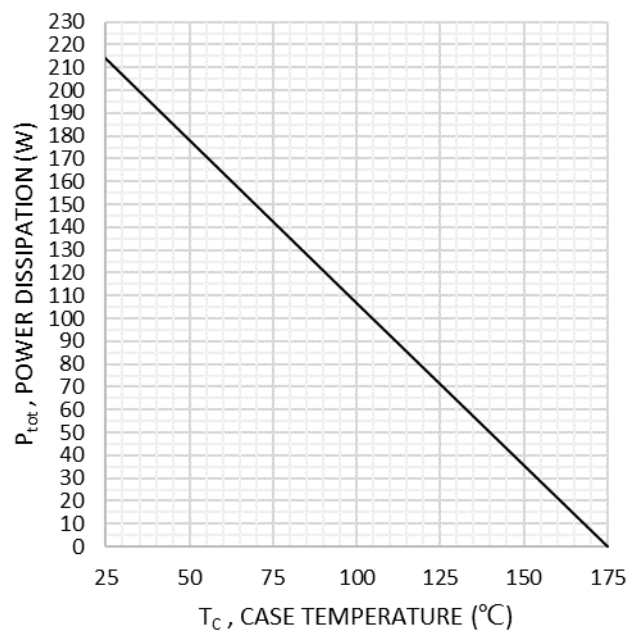

**Fig. 4 Power dissipation as a function of case temperature** ( $T_{vj} \leq 175^{\circ}C$ )

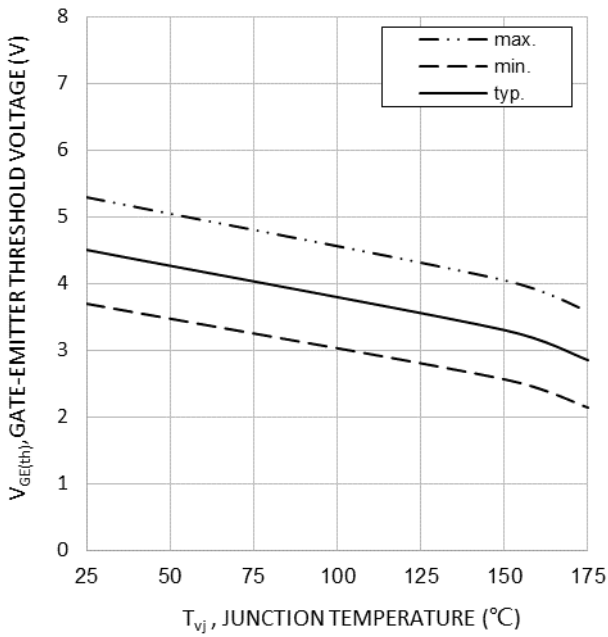

Fig. 5 Gate-emitter threshold voltage as a function of junction temperature ( $I_C=0.40\text{mA}$ )

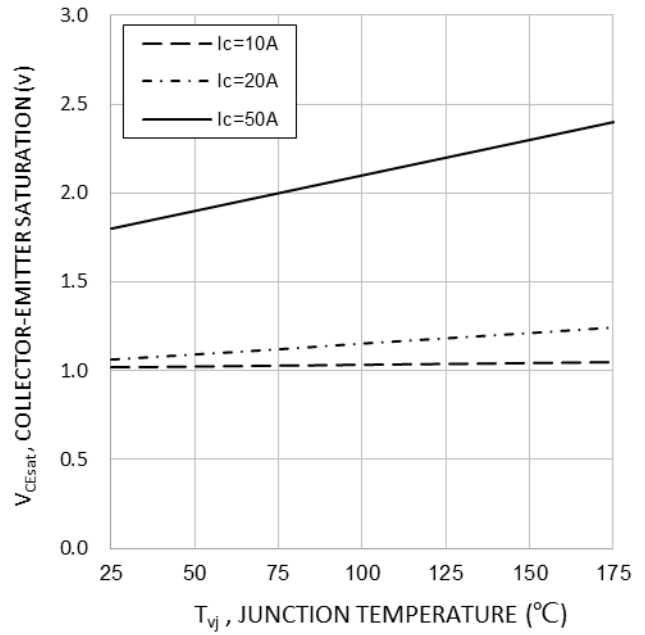

Fig. 6 Typical collector-emitter saturation voltage as a function of junction temperature ( $V_{GE}=15\text{V}$ )

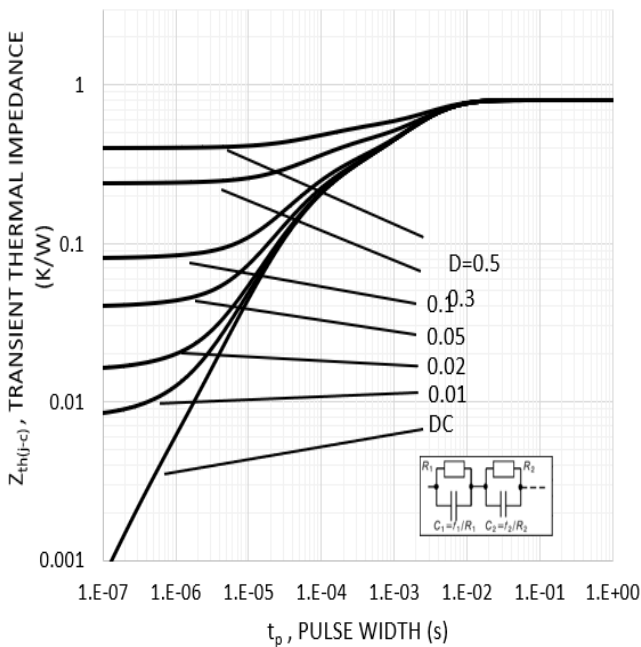

Fig. 7 IGBT transient thermal impedance ( $D=t_p/T$ )

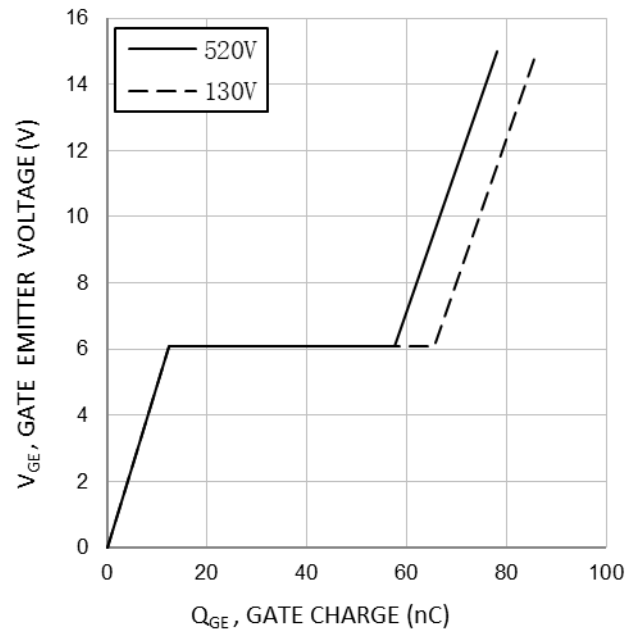
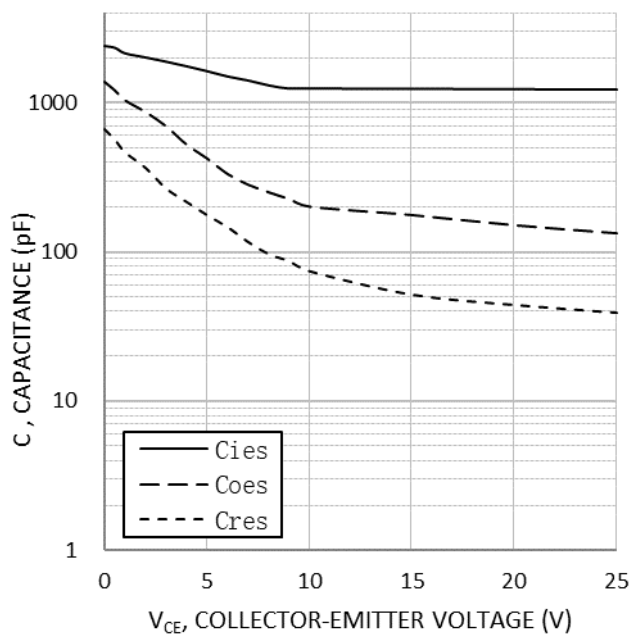

Fig. 8 Typical gate charge ( $I_C=50\text{A}$ )



**Fig. 9 Typical capacitance as a function of collector-emitter voltage (V<sub>GE</sub>=0V, f=1MHz)**

# Package Information

TO-247-3L

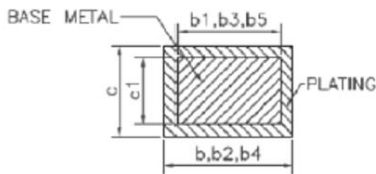
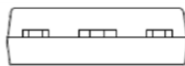
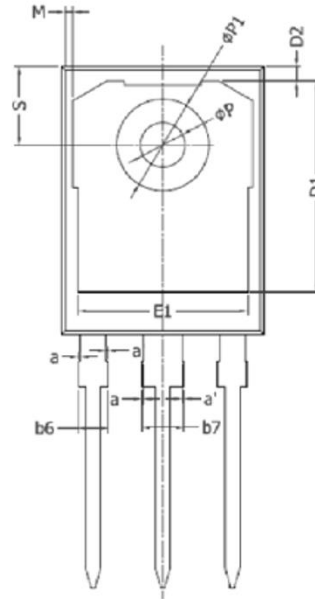
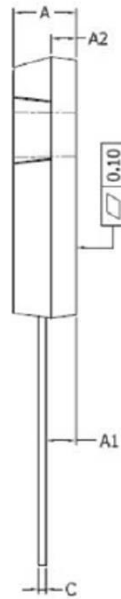
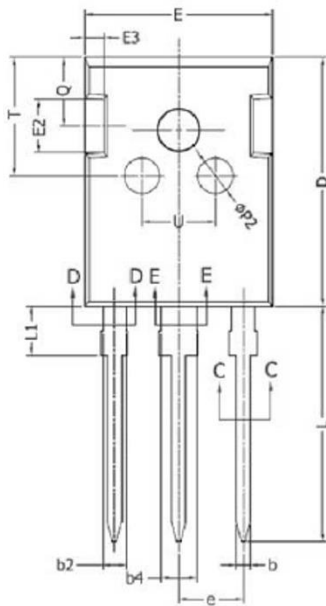

SECTION C-C, D-D & E-E

SYMBOL	MIN	NOM	MAX
A	4.90	5.00	5.10
A1	2.31	2.41	2.51
A2	1.90	2.00	2.10
a	0	---	0.15
a'	0	---	0.15
b	1.16	---	1.26
b1	1.15	1.2	1.22
b2	1.96	---	2.06
b3	1.95	2.00	2.02
b4	2.96	---	3.06
b5	2.96	3.00	3.02
b6	---	---	2.25
b7	---	---	3.25
c	0.59	---	0.66
c1	0.58	0.60	0.62
D	20.90	21.00	21.10
D1	16.25	16.55	16.85
D2	1.05	1.17	1.35
E	15.70	15.80	15.90
E1	13.10	13.30	13.50
E2	4.40	4.50	4.60
E3	1.50	1.60	1.70
e	5.436 BSC		
L	19.80	19.92	20.10
L1	---	---	4.30
M	0.35	---	0.95
P	3.40	3.50	3.60
P1	7.00	---	7.40
P2	2.40	2.50	2.60
Q	5.60	---	6.00
S	6.05	6.15	6.25
T	9.80	---	10.20
U	6.00	---	6.40